

ELEVATION 1

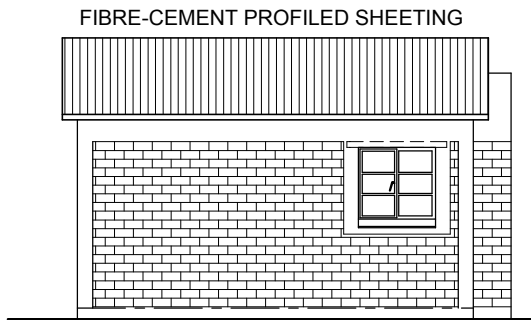

ELEVATION 3

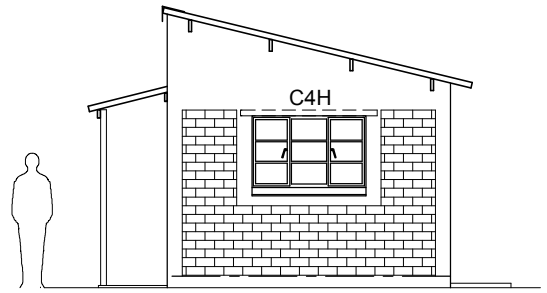

ELEVATION 2

200mm PLASTER BANDS AT CORNERS AND AROUND DOORS AND WINDOWS

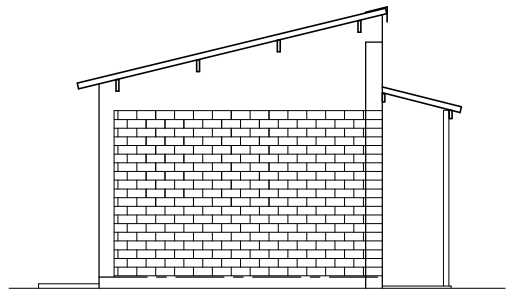

ELEVATION 4

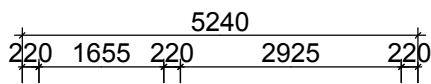

CONCRETE APRON

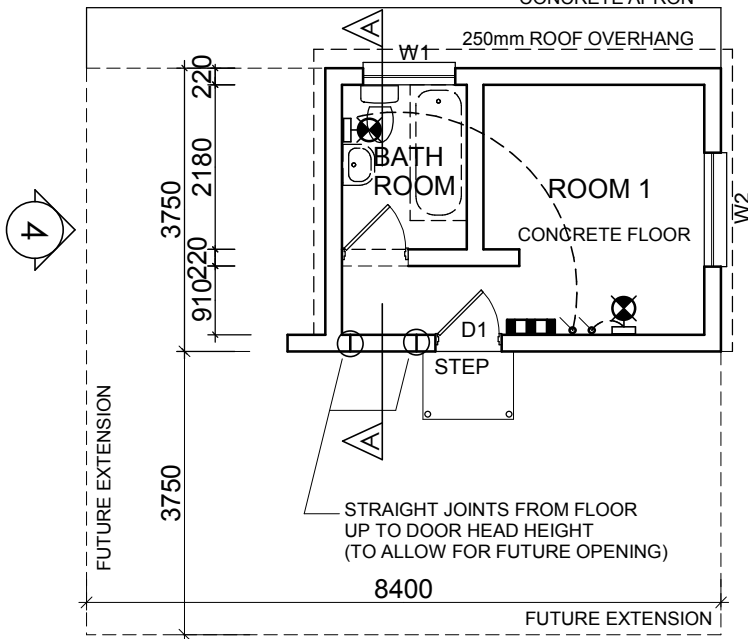

PLAN



- PLUGBOARD OR D.B.
 - WALL LIGHT FITTING
 - SWITCH
- ELECTRICAL**

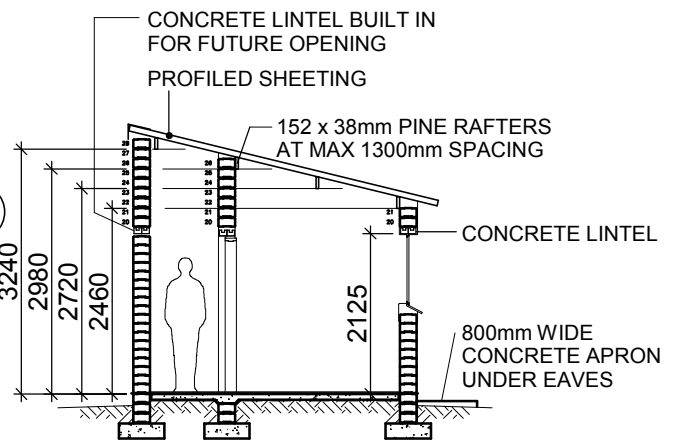

SIZE OF FOUNDATIONS TO BE DESIGNED BY ENGINEER TO SUIT LOCAL SITE CONDITIONS

SECTION A-A

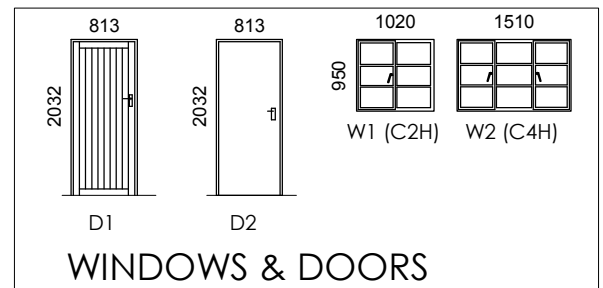

WINDOWS & DOORS

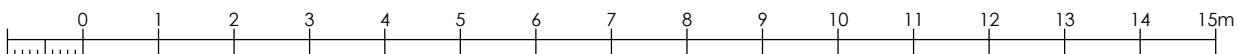

www.hydraform.co.za

© HYDRAFORM 2008

HOUSE TYPE 1(a) - BASIC - ONE ROOM

DRAWING No
RD96-01

REVISION